

One day, i was going back home from buying groceries.

But i got caught in an accident.



*Luckily, i survived from the accident.
But in exchange, i lost my arms.
I was really depressed when i found out about it.*

3 days after the accident, a mysterious man visited me. He said that he can help me with the arms and he also propose me to join a secret organization that run by the government in exchange.



I accepted the offer and they gave me this mechanical arm in exchange i have to work for them.

I know this is a very dangerous job but if i can still have arms then i will do it without a doubt.

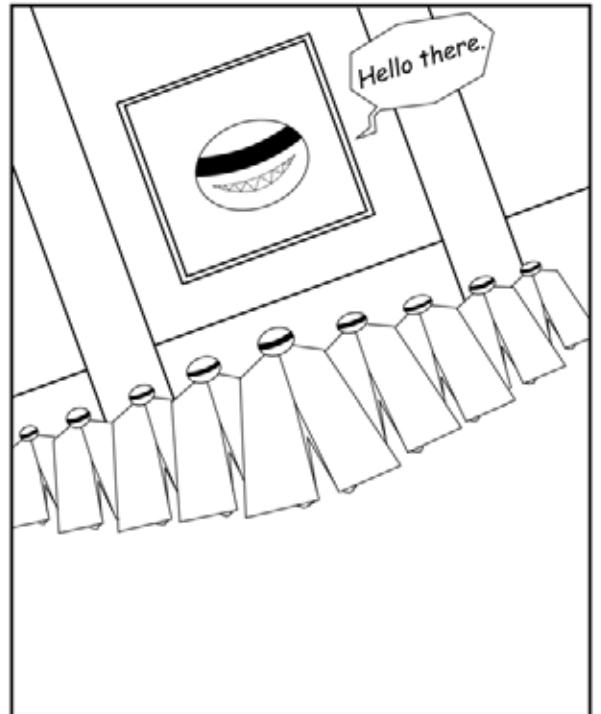

Oh! Hello.

Ela, please.

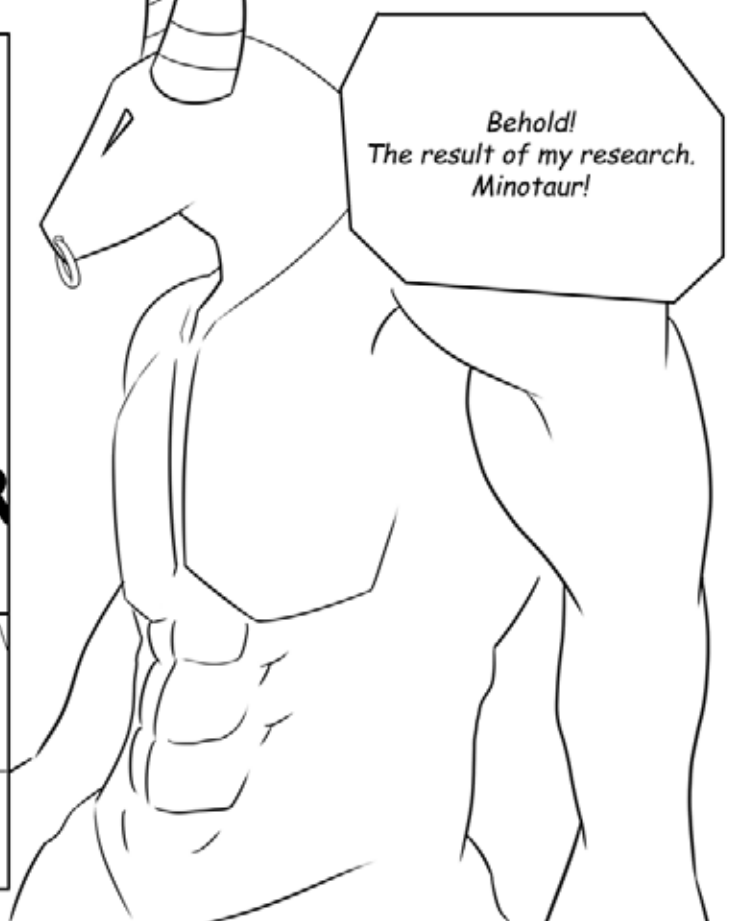
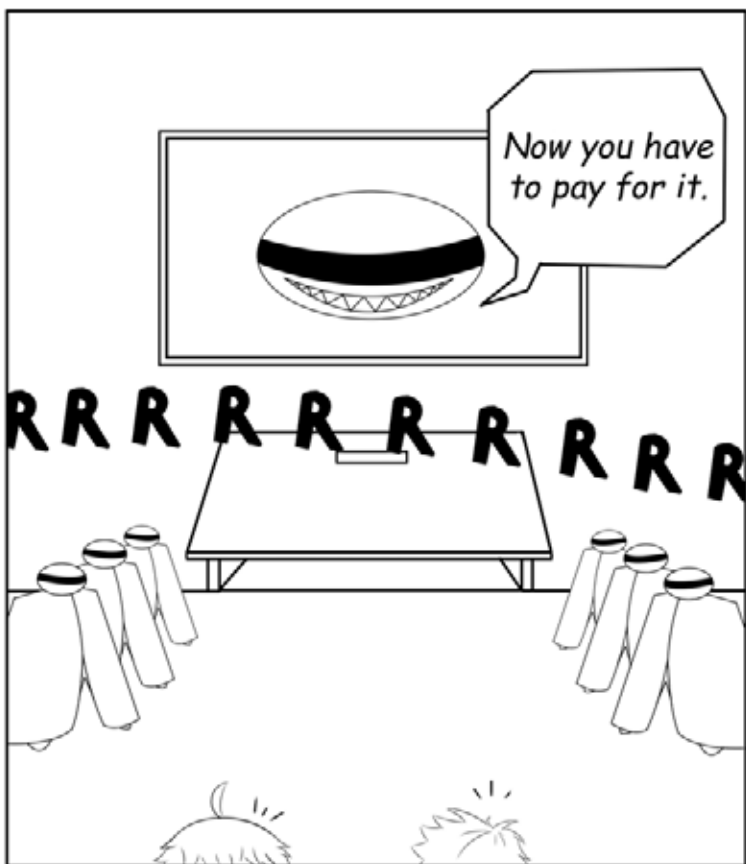
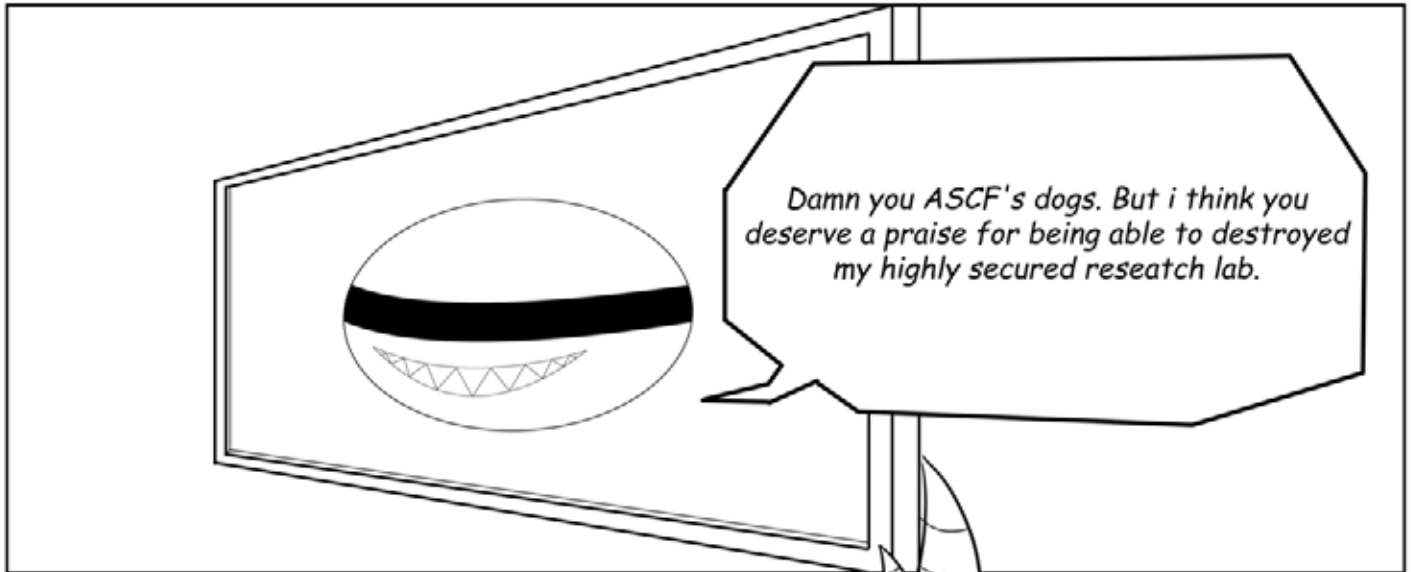

WHOOOSH!



IT'S
COMING!

WHAM!!



HUH?

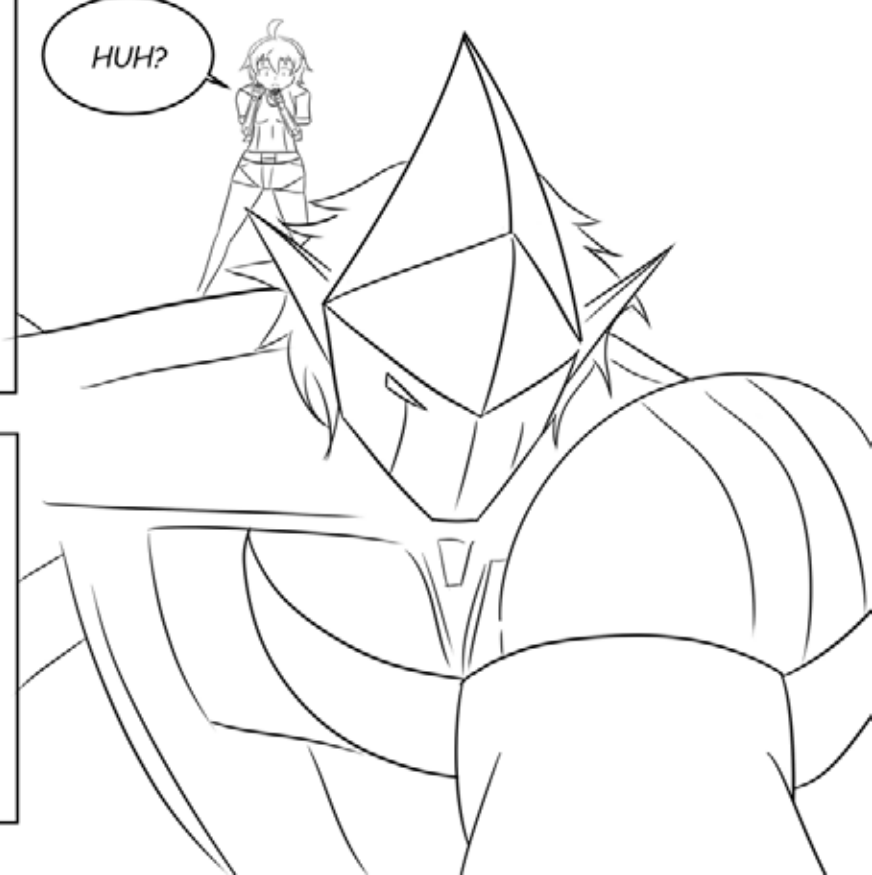

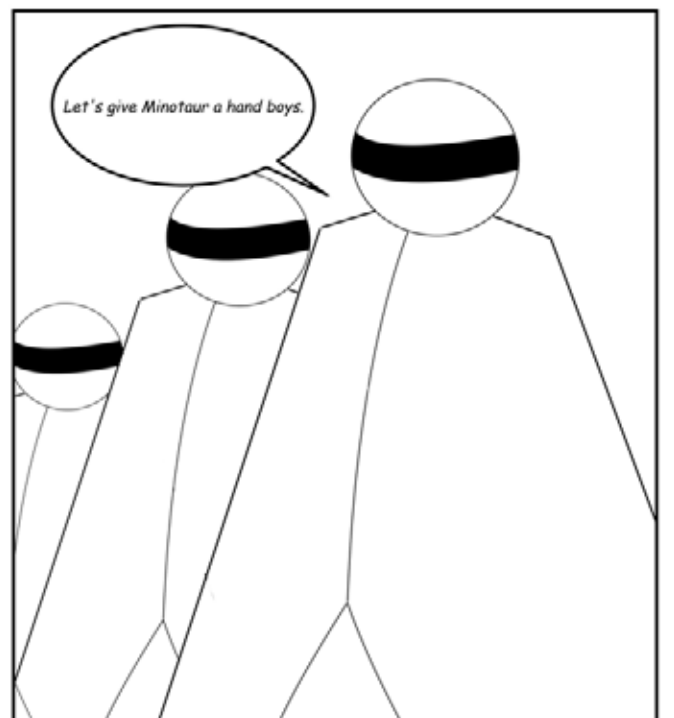
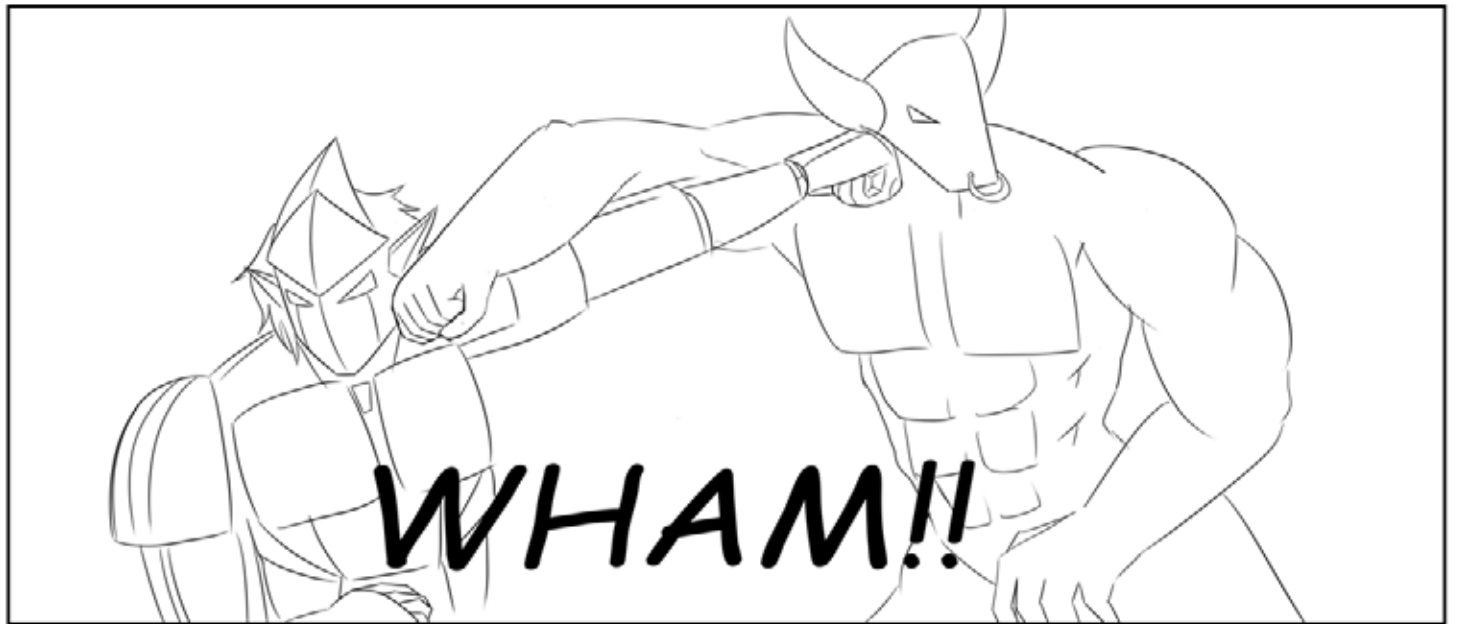
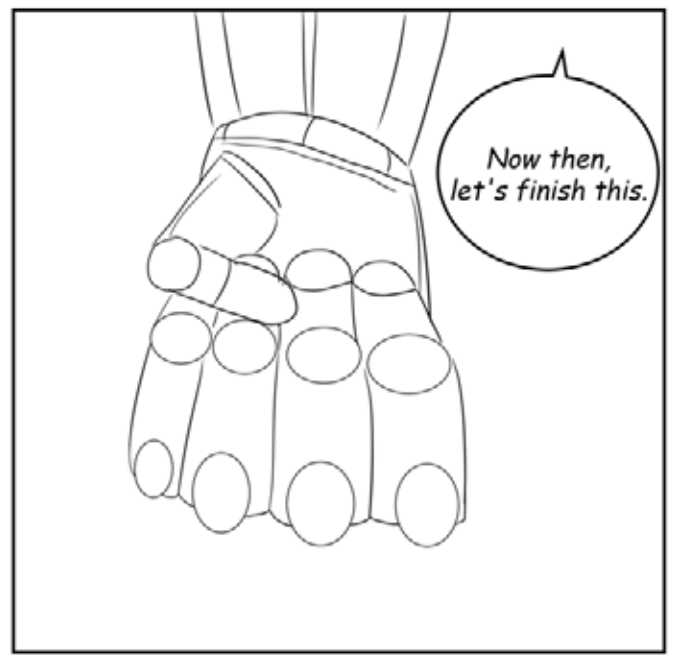

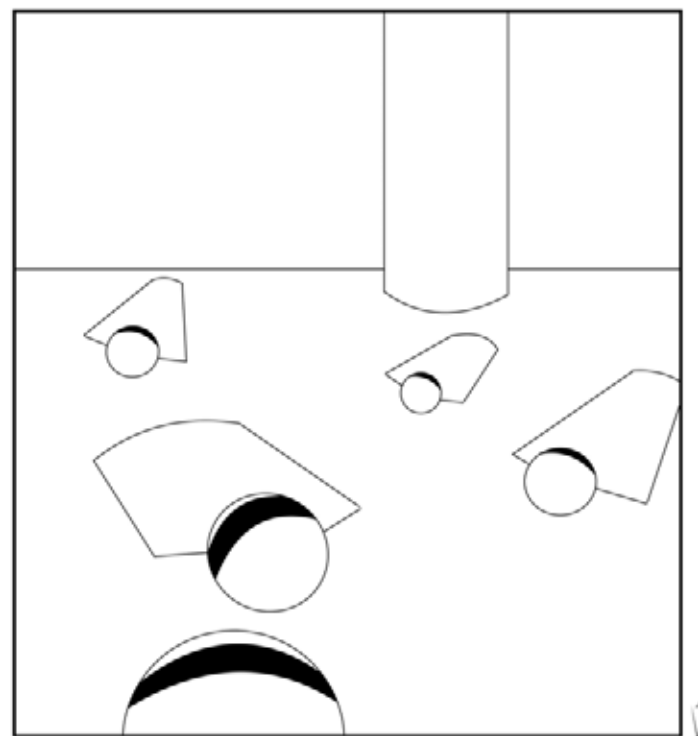
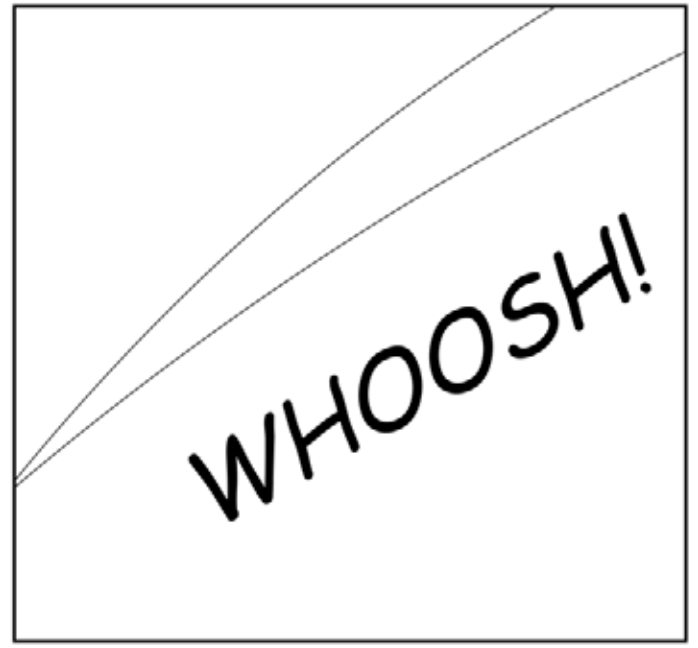

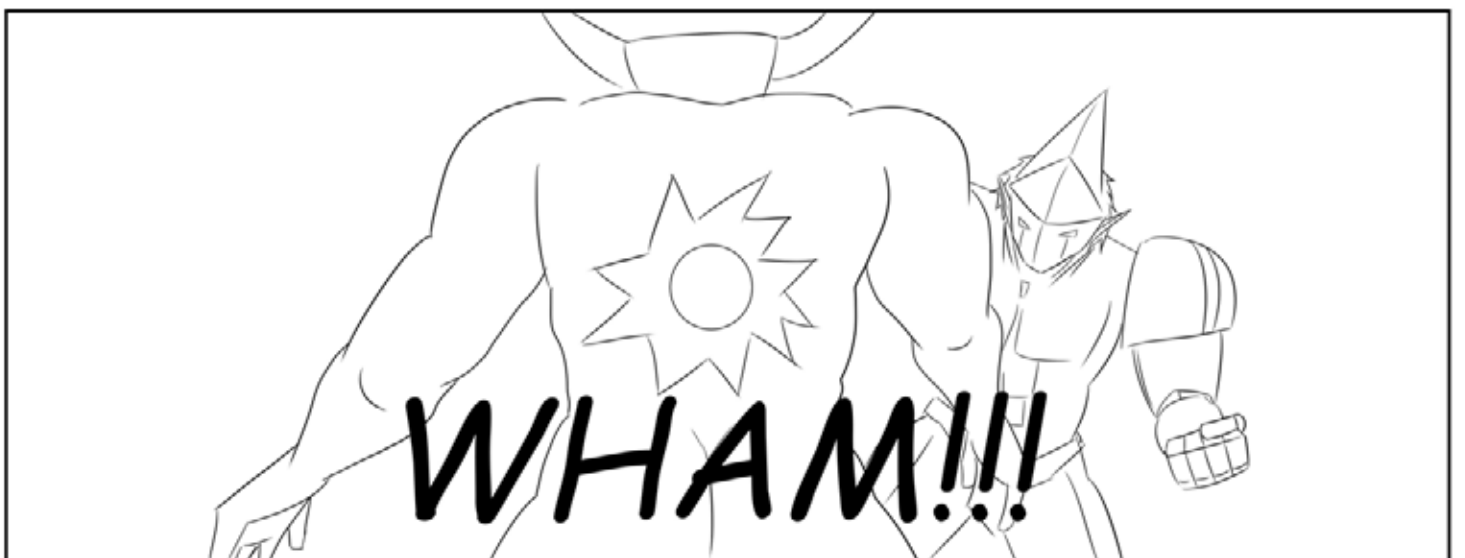
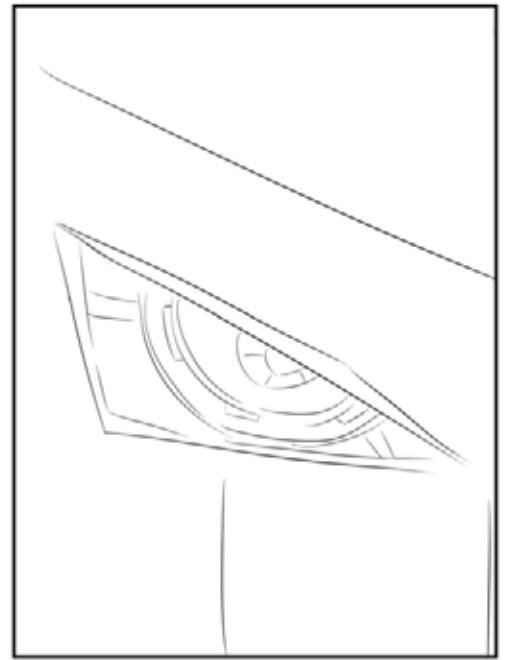
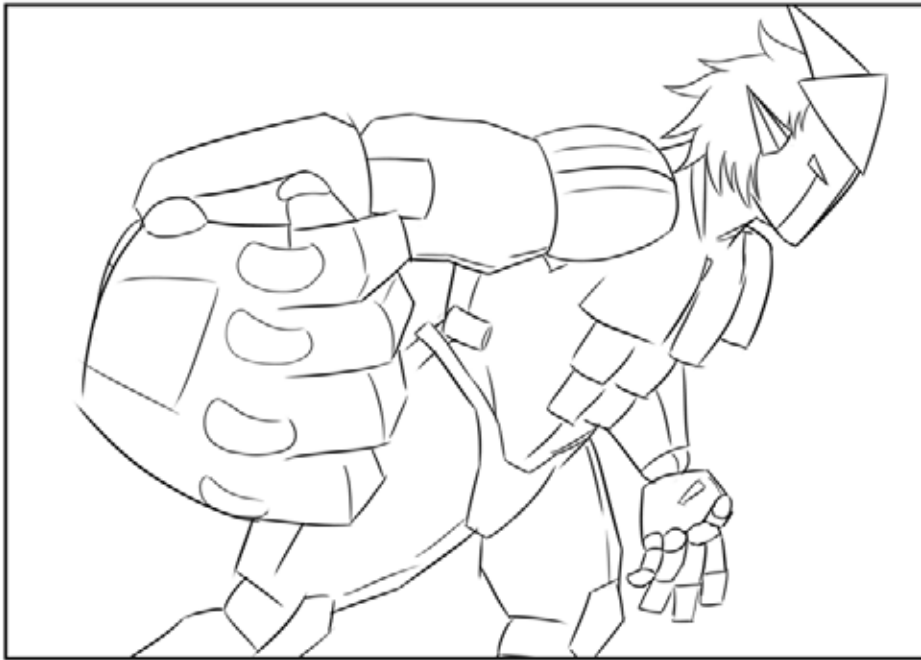
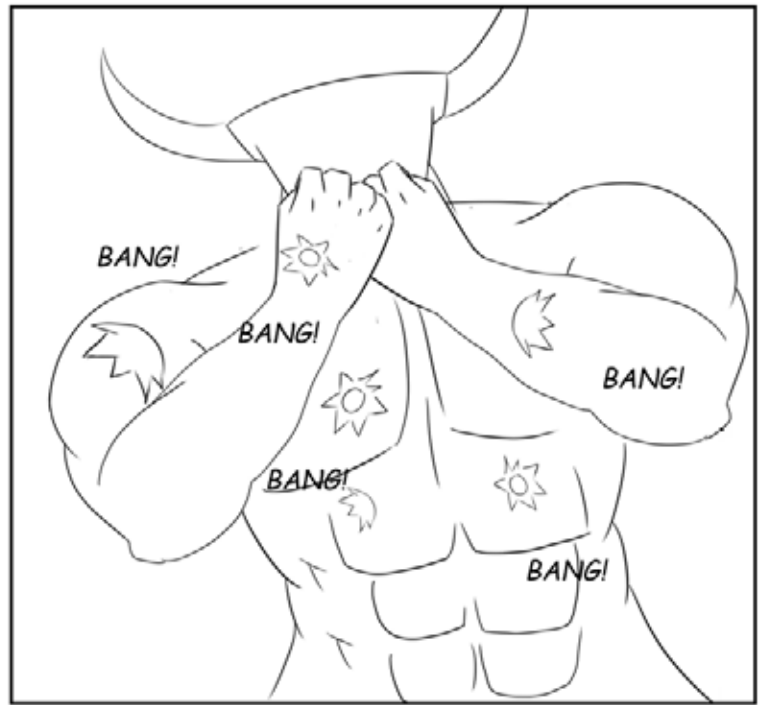
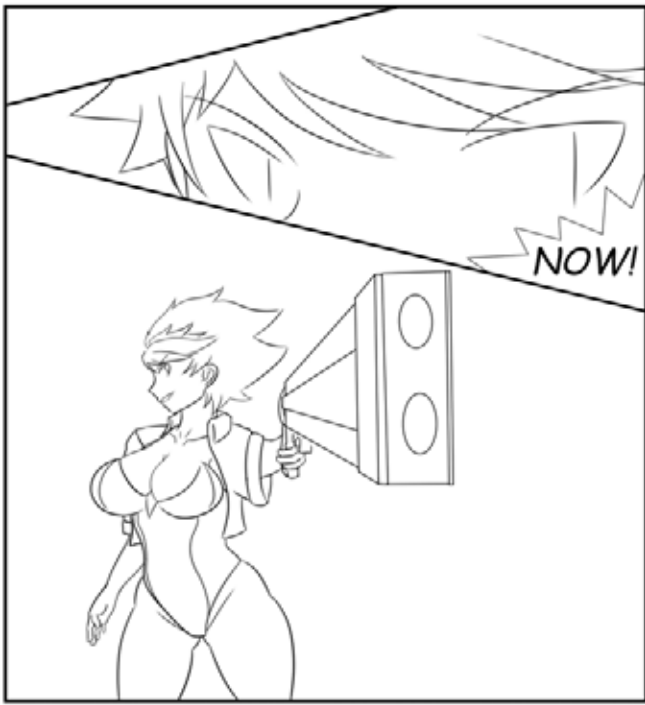

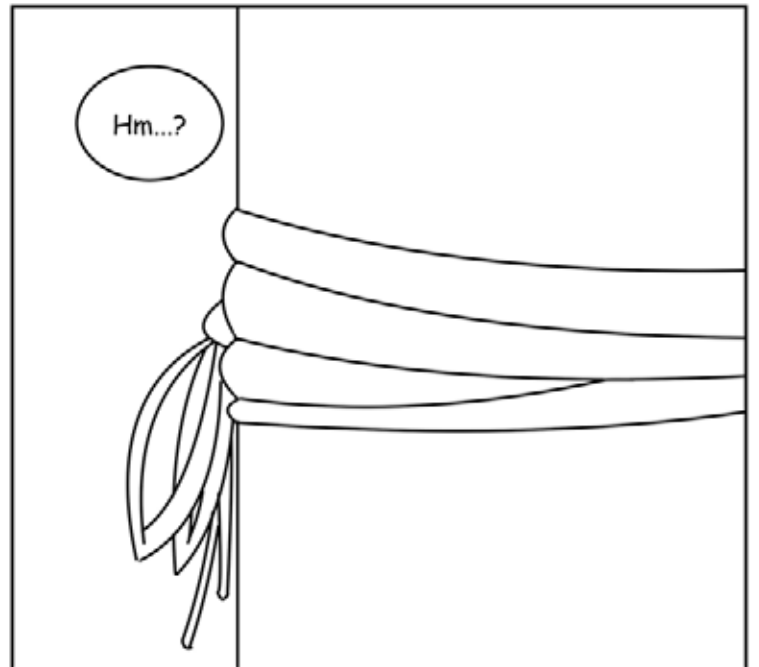

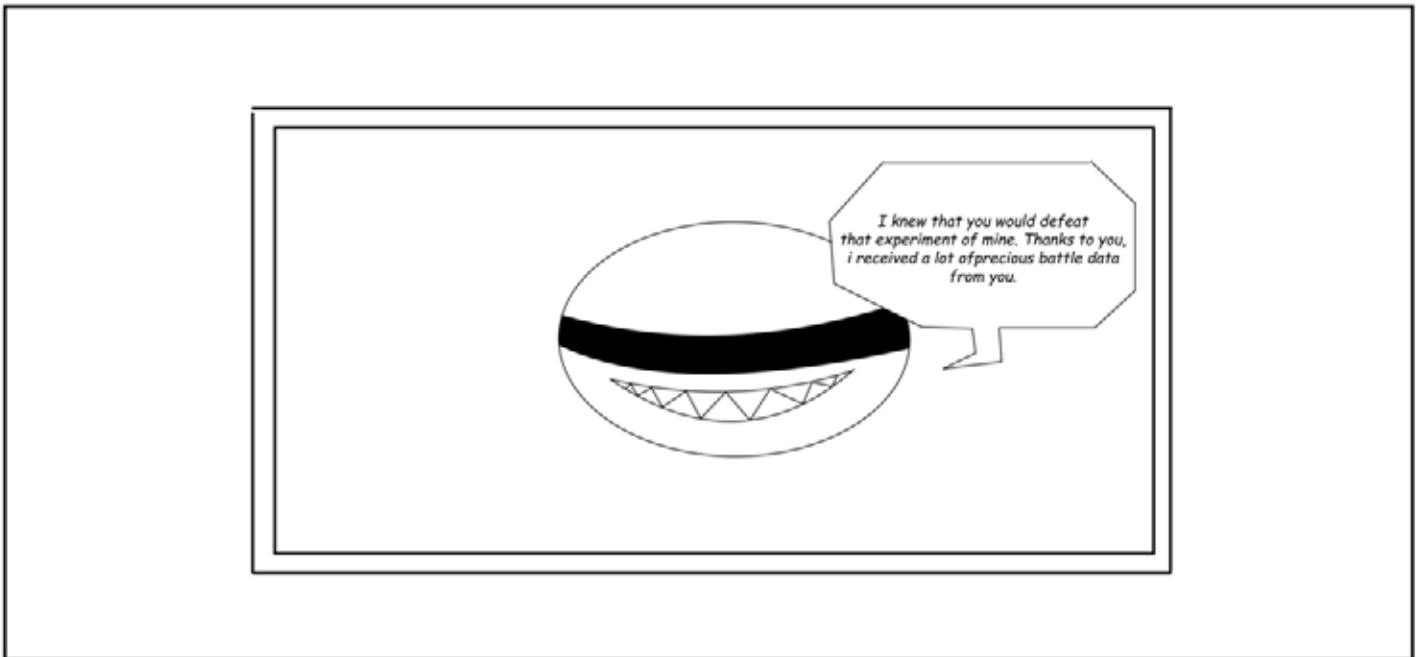
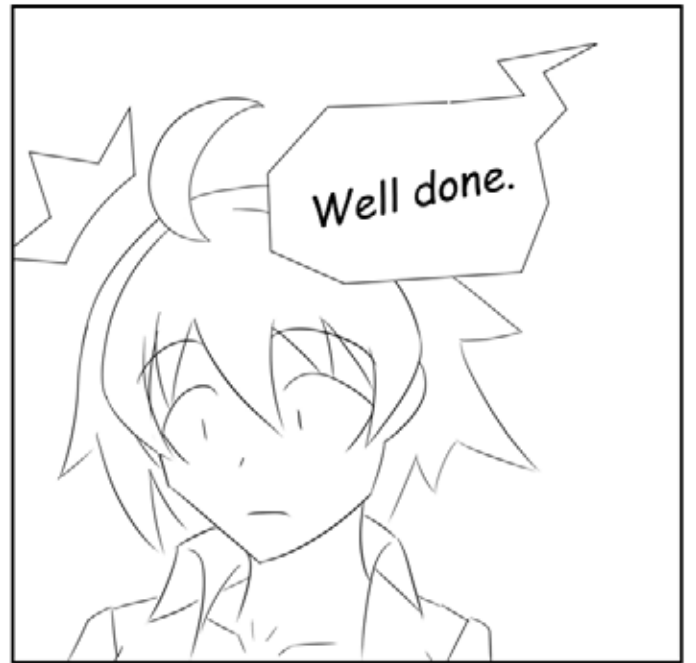
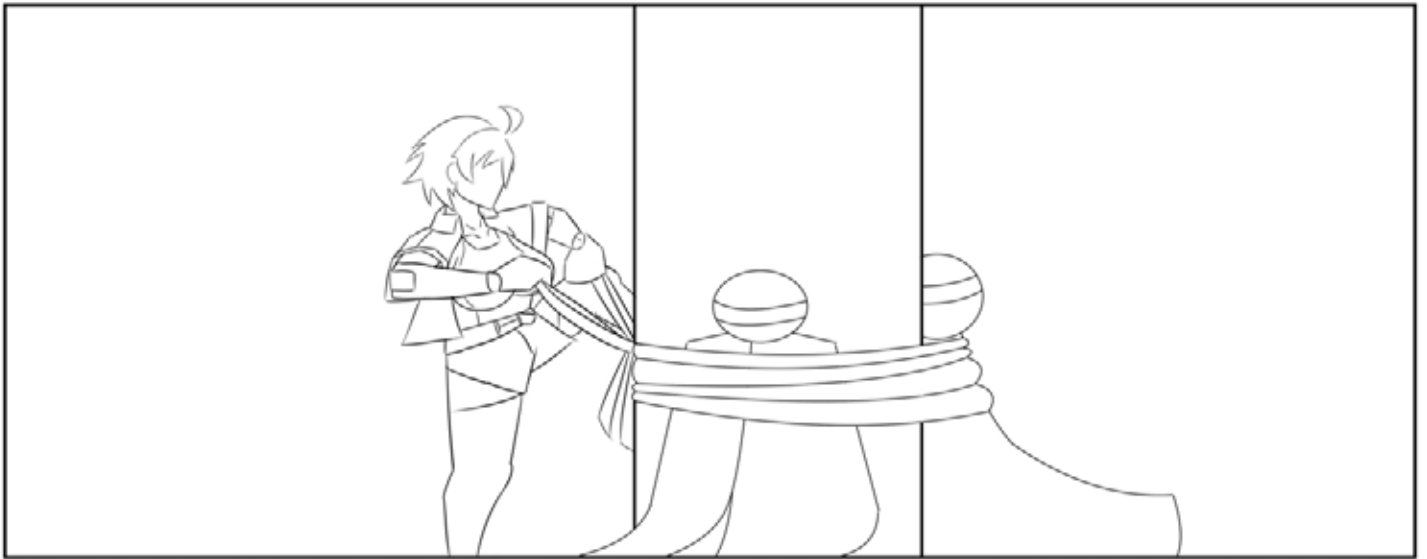

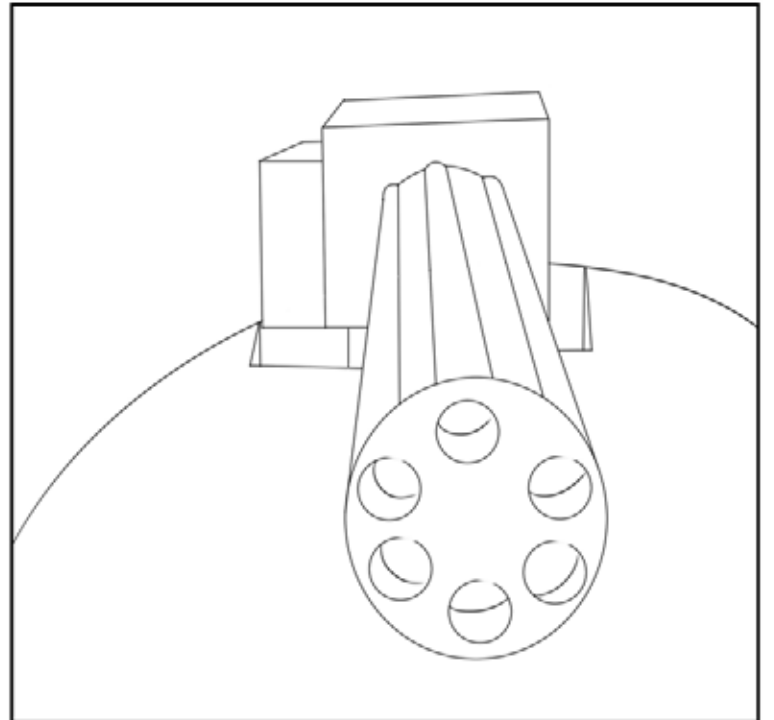
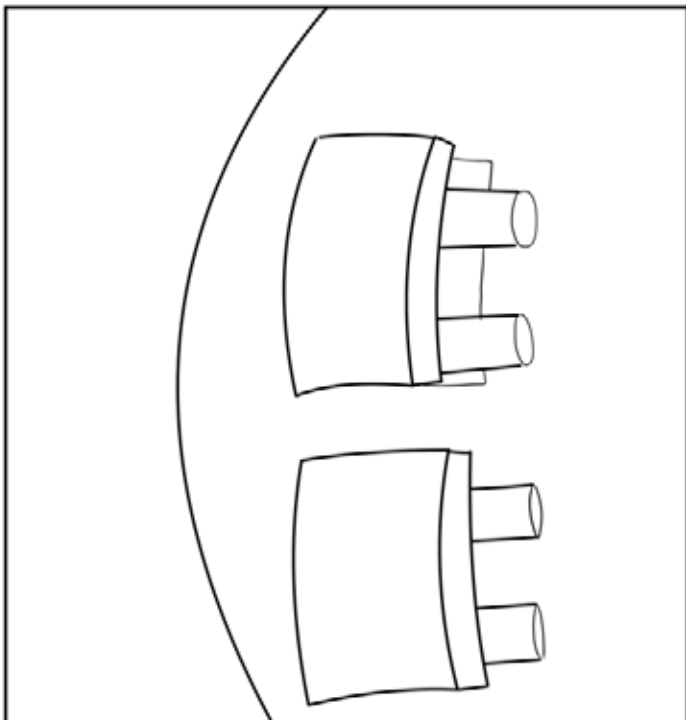
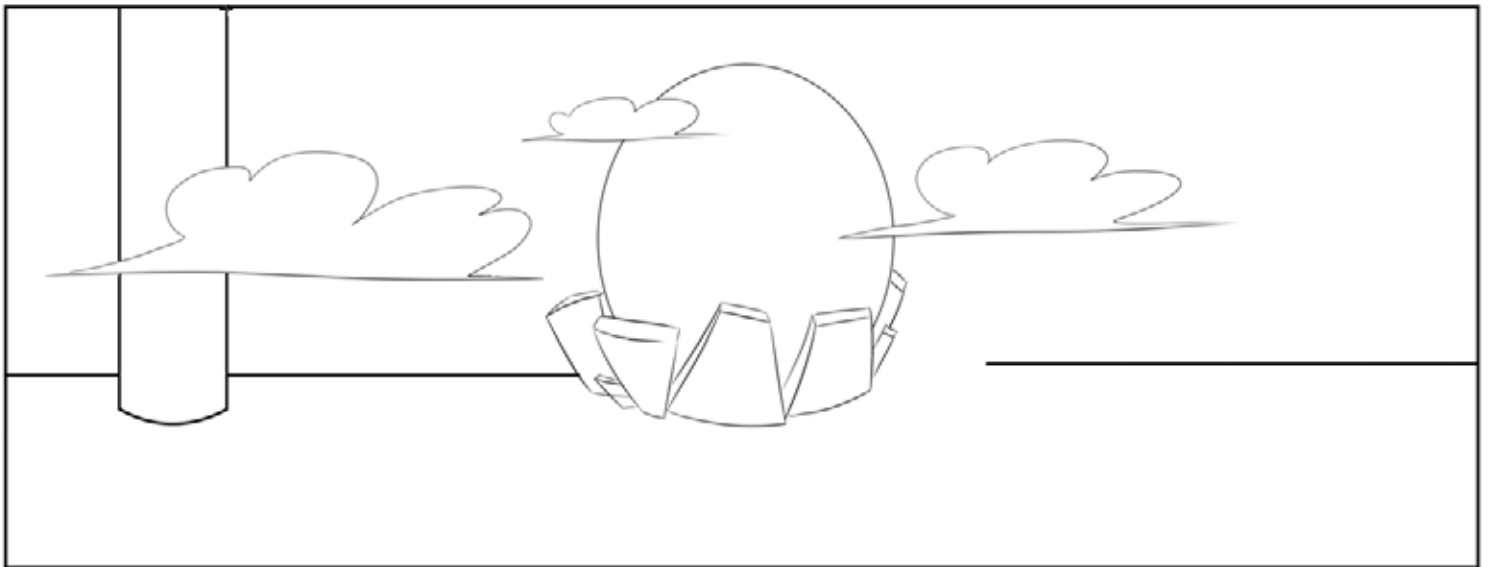
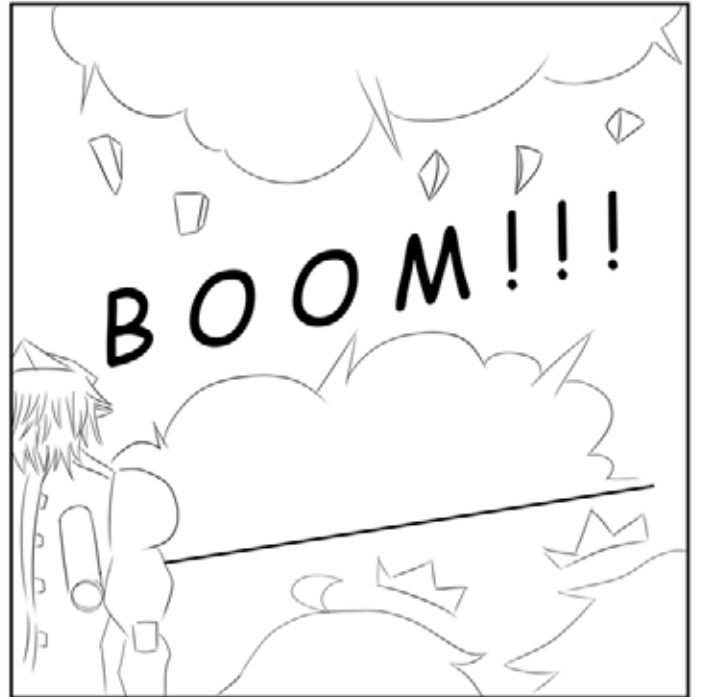

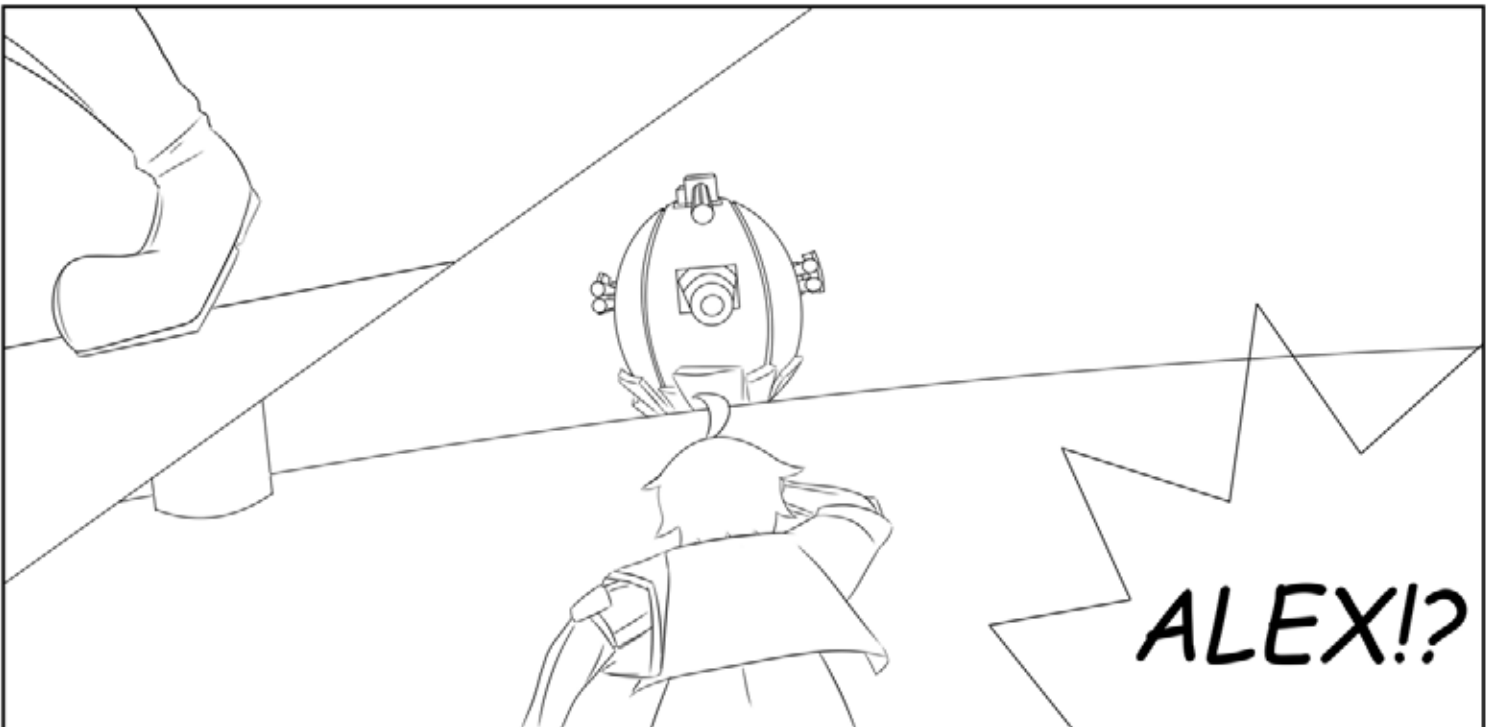
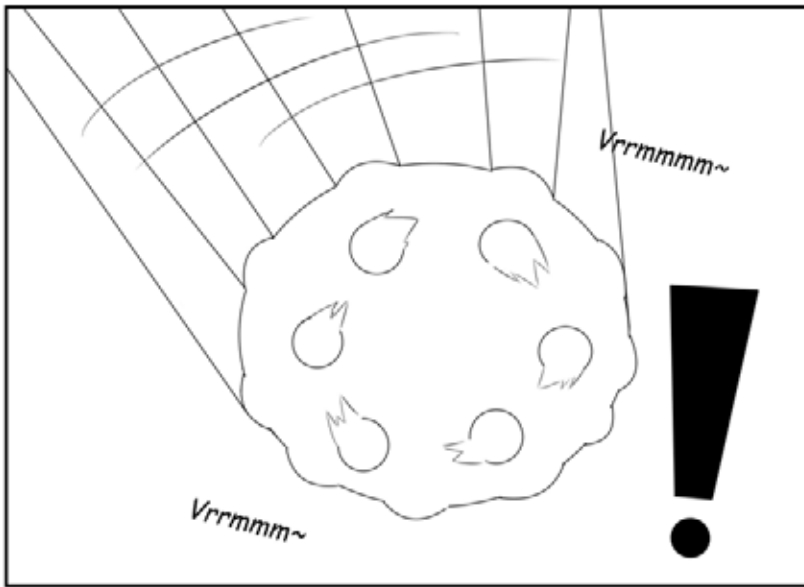
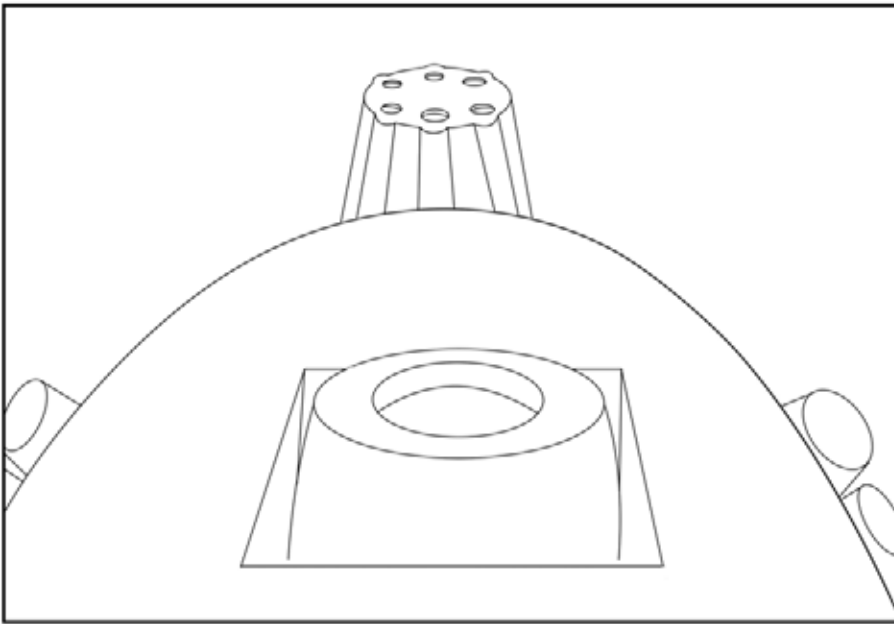

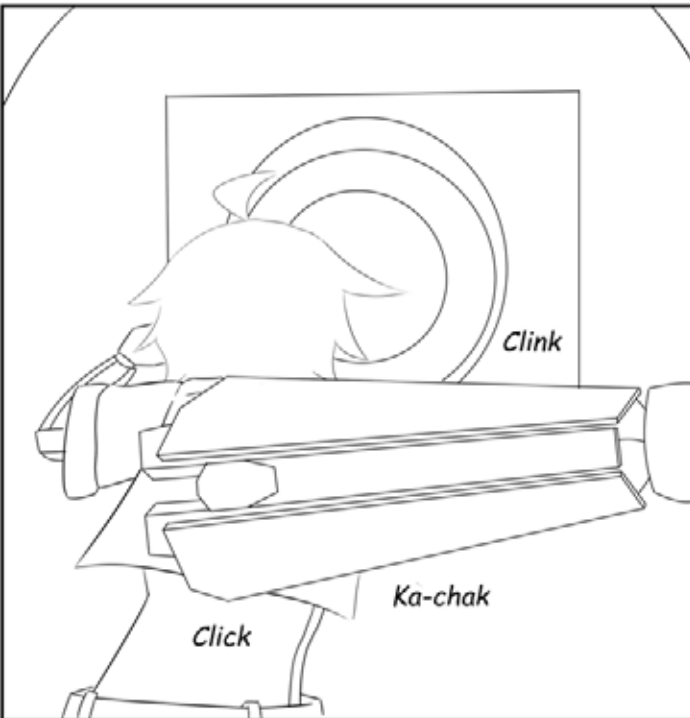
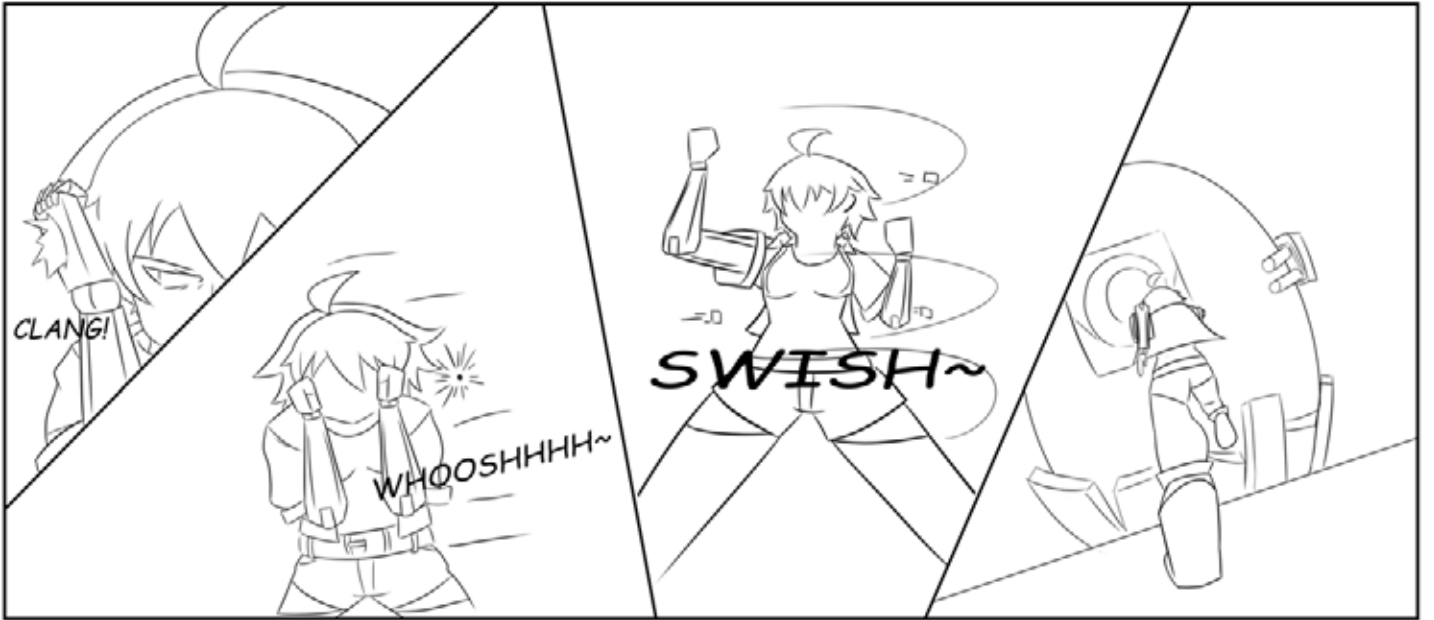
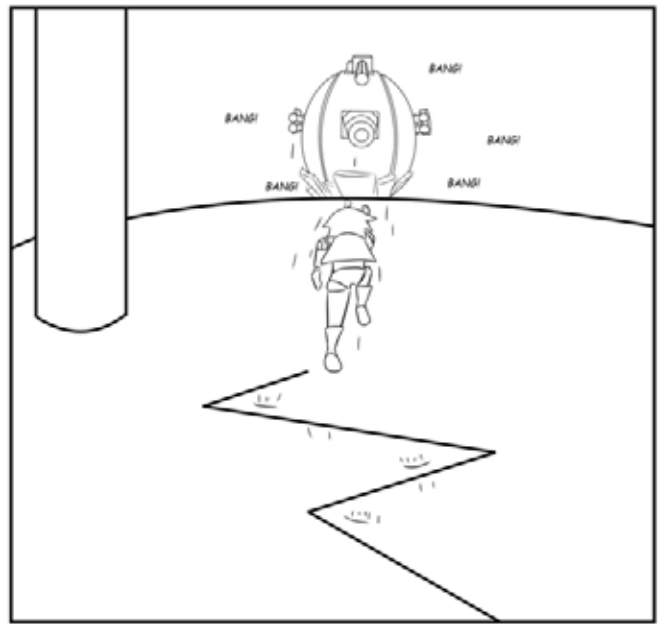
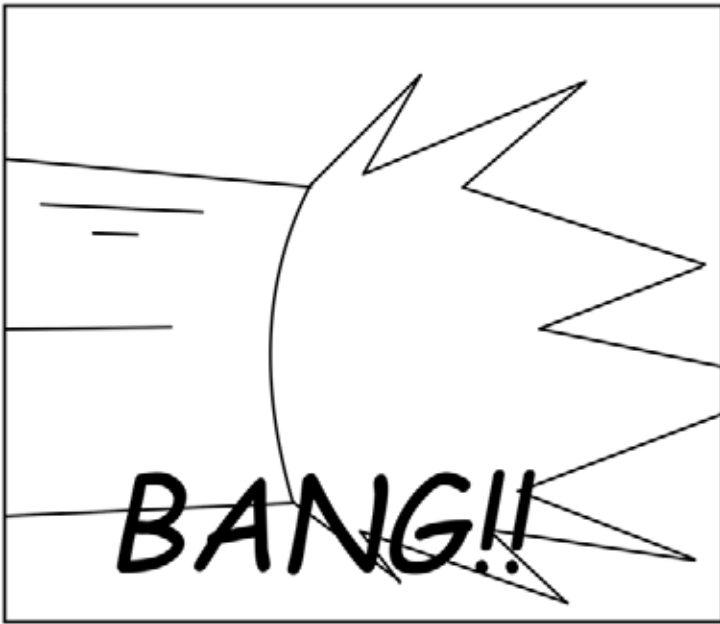

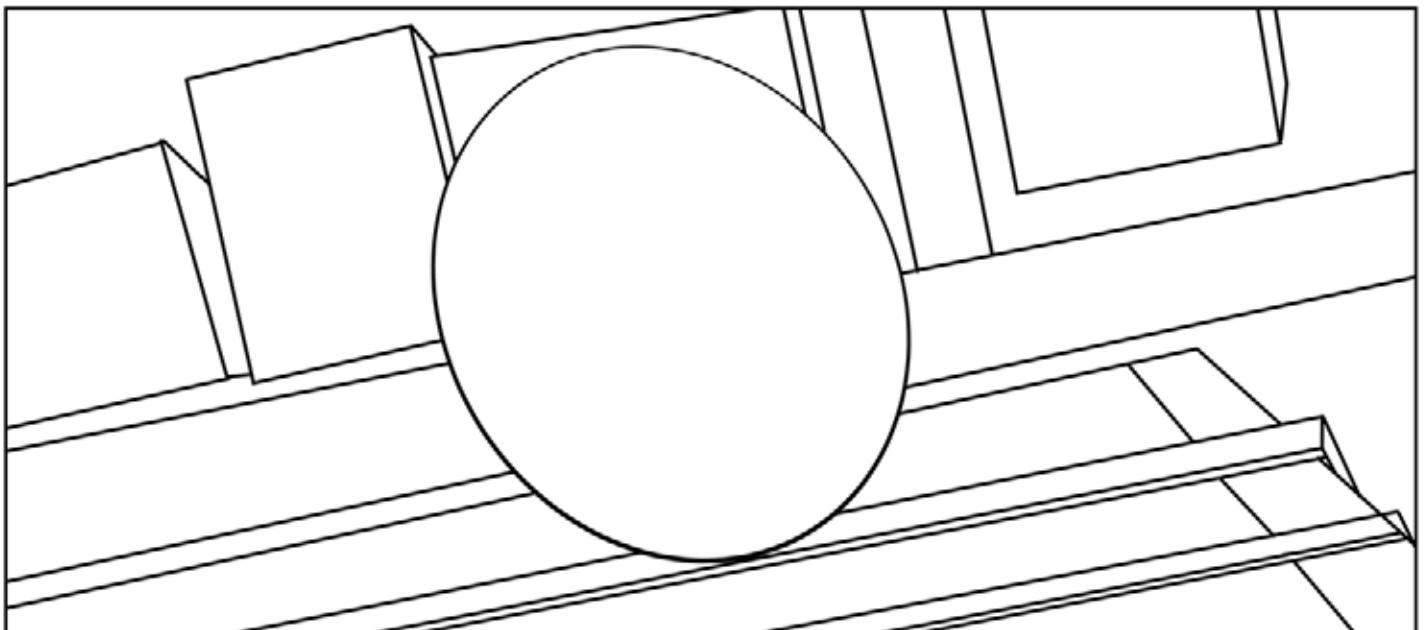
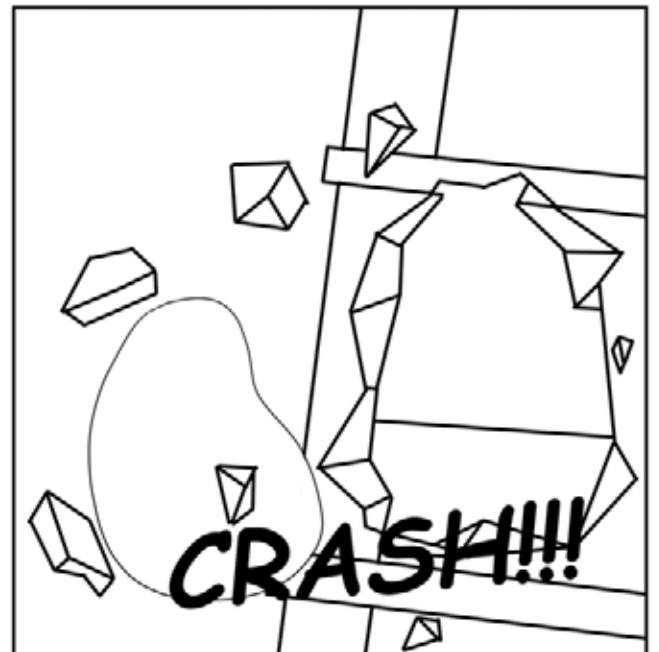
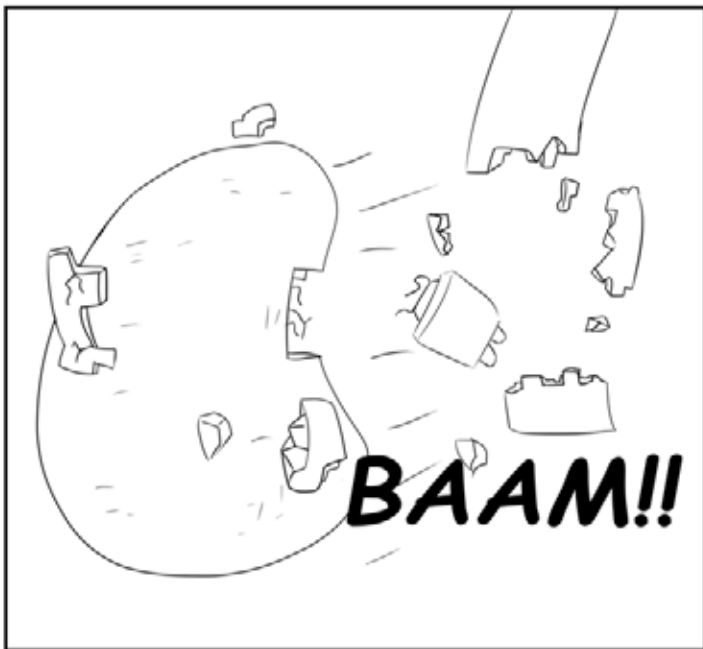
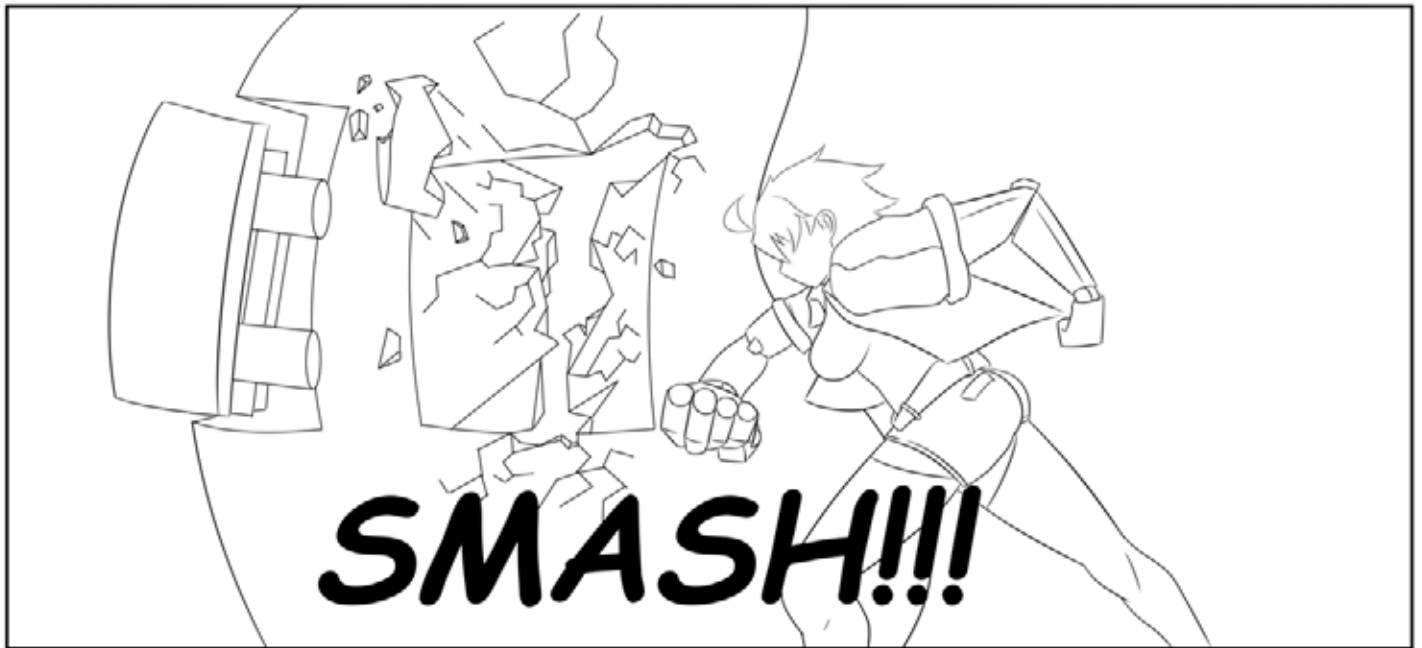

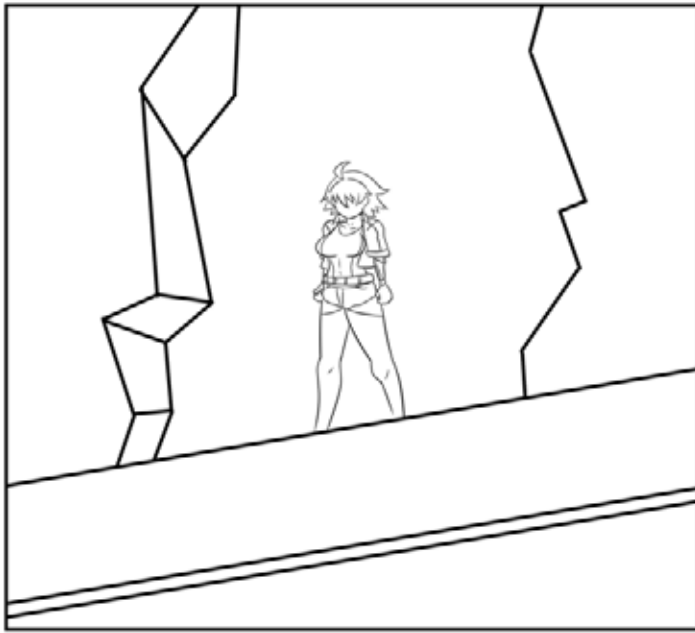

ALEX

KNUCKLEHEAD

Author: Thong Nguyen.

*Don't you think so,
Alex?*

END